



GRISE I VÆKST

Specialkonsulent
Erik Damsted
SEGES, VSP

LMO
onsdag den 28. september 2016

VENTILATION AF SVINESTALD

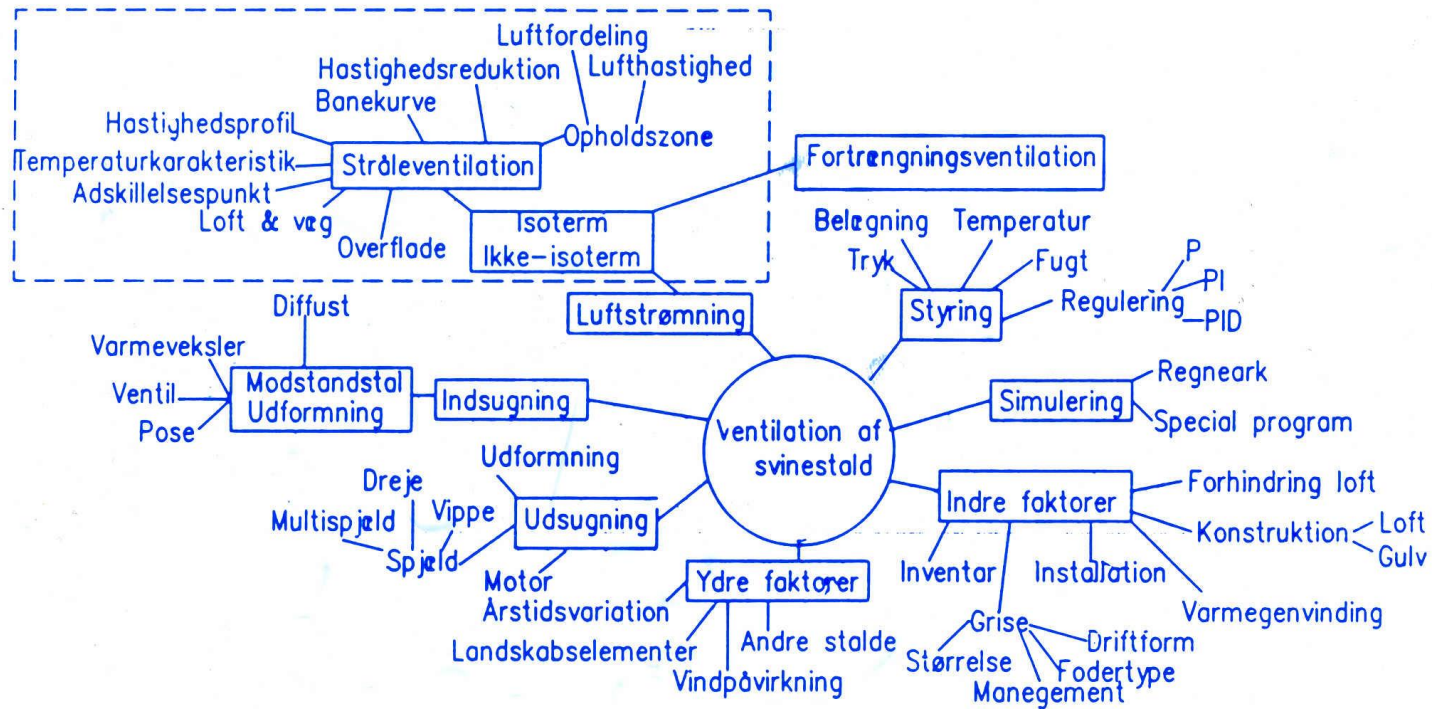

YDRE FORHOLD OMKRING STALDBYGNINGER

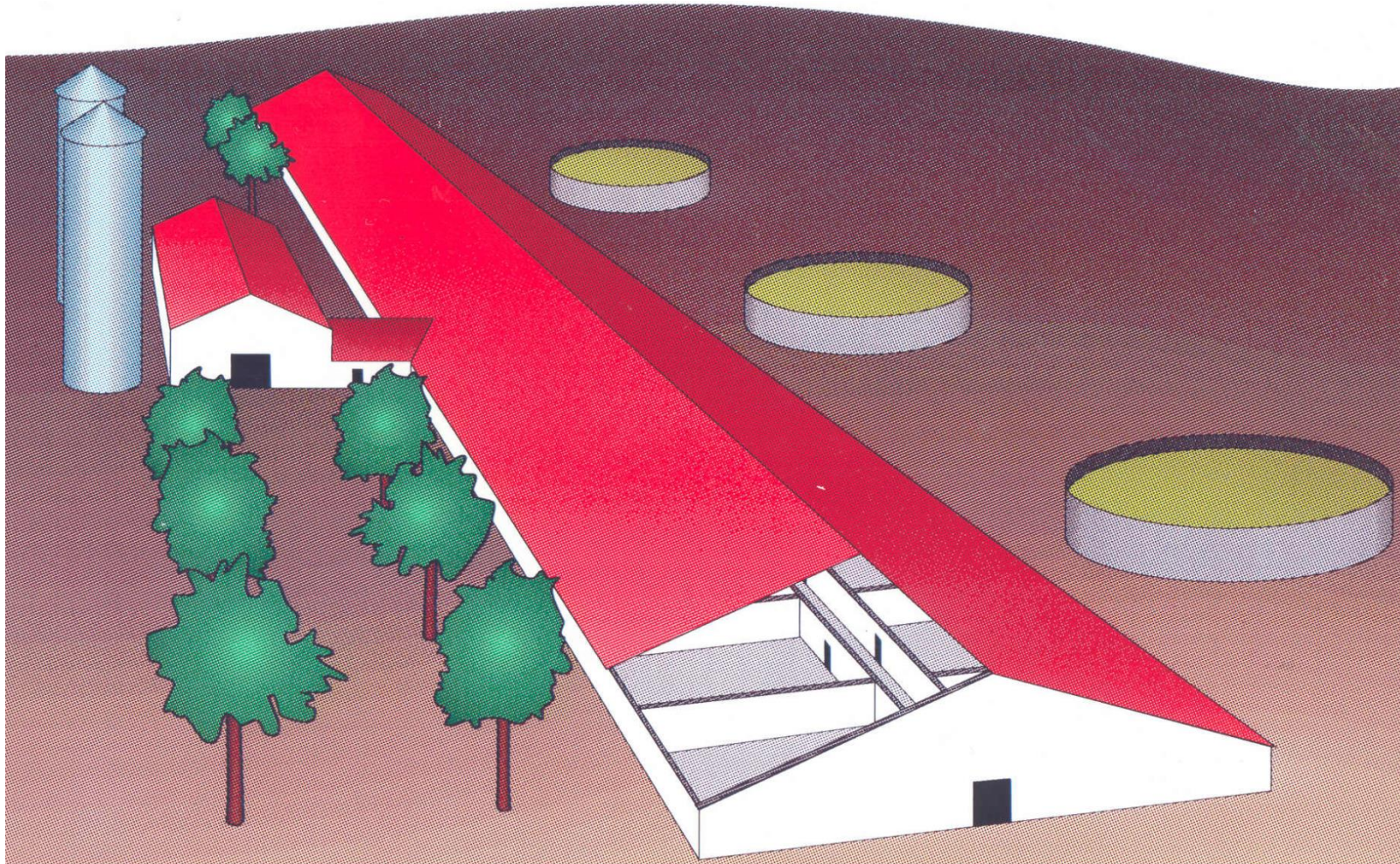

VINDPÅVIRKNING

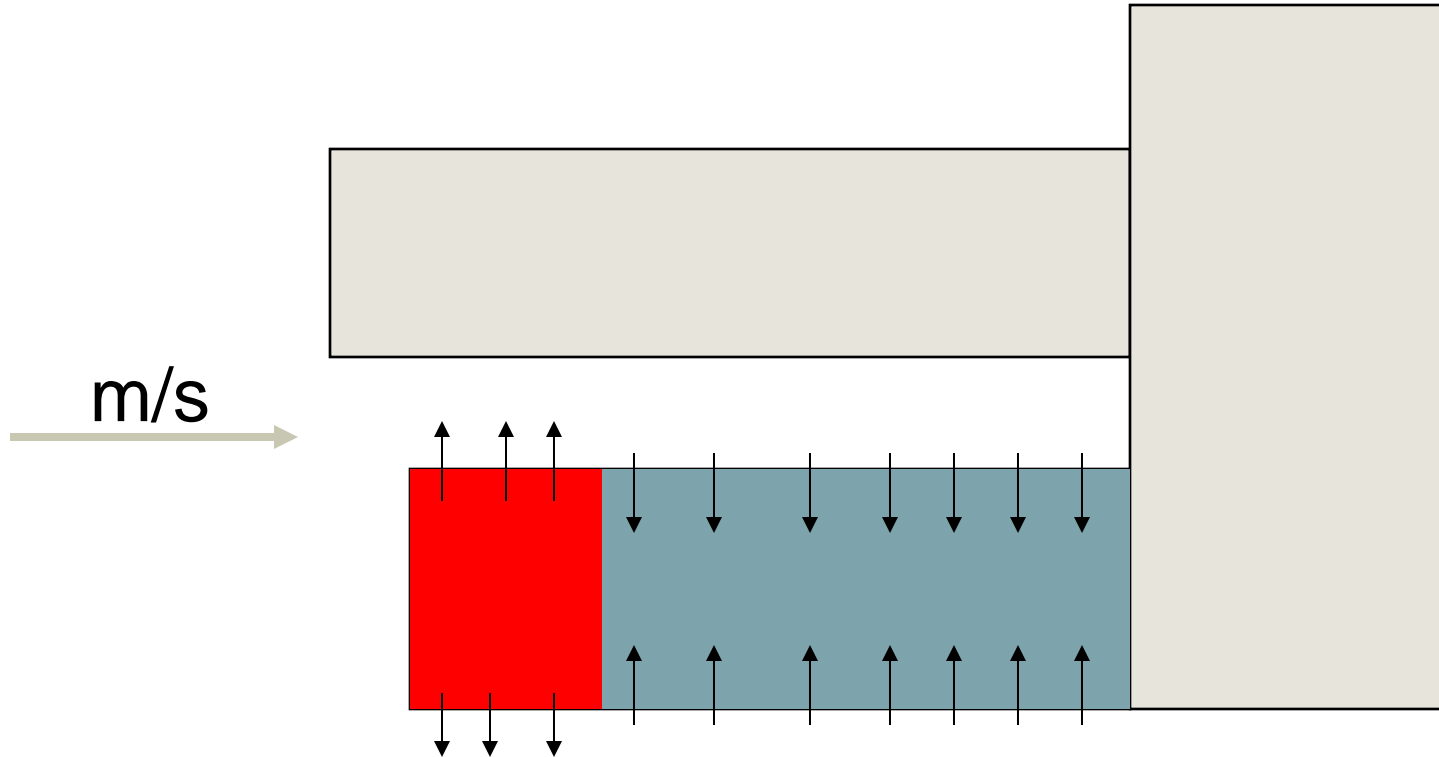

TEGN PÅ VINDPÅVIRKNING



VINDPÅVIRKNING - AFHJÆLPNING

- Staldluft suges ud af vægventil



REDUKTION AF VINDPÅVIRKNING

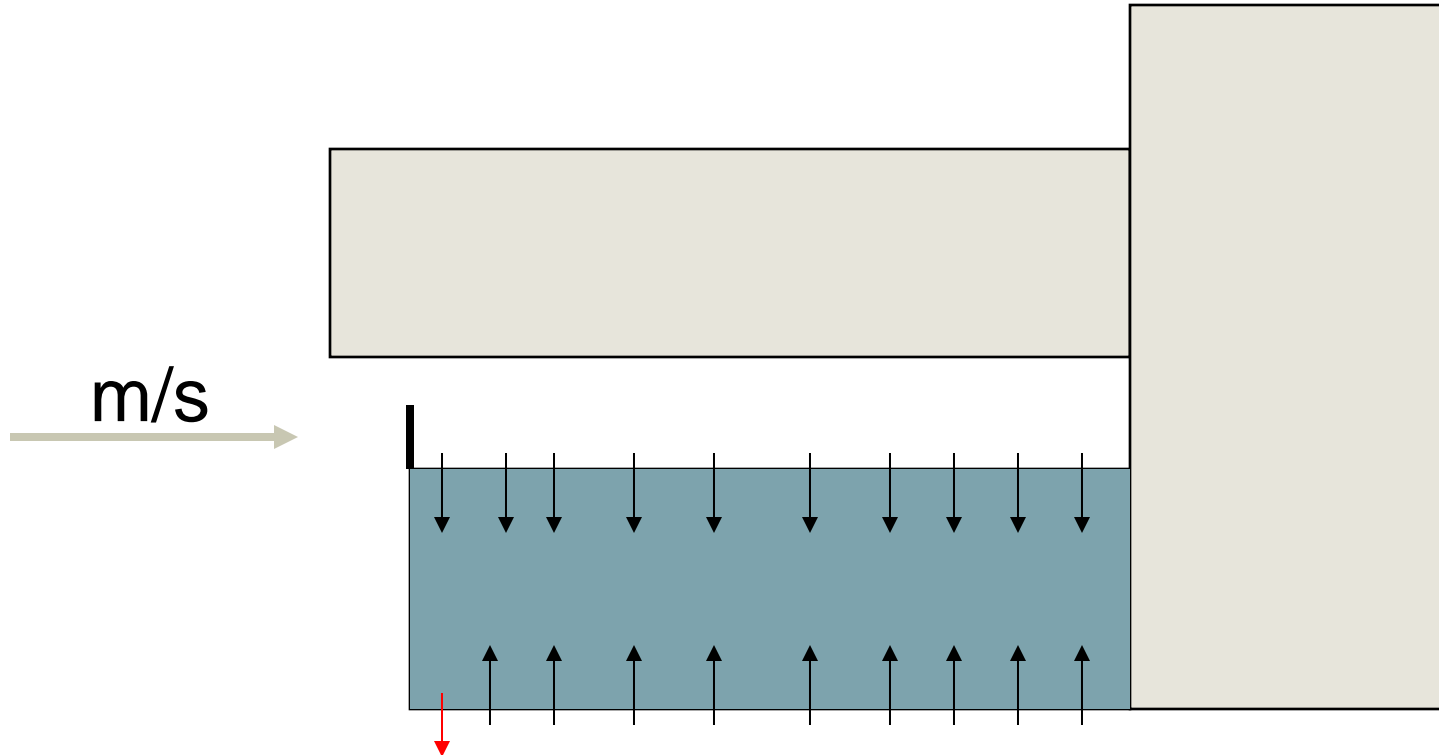

VINDAFSKÆRMNING



VINDAFSKÆRMNING



VINDAFSKÆRMNING



TRYKTAB VINDAFSKÆRMNING

Tryktab Ventil Pa	Areal ventil/vindafsk.	Tryktab Vindafs. Pa
10 Pa	0,5 : 1	2,5 Pa
10 Pa	1 : 1	10 Pa
10 Pa	1,5 : 1	22,5 Pa
10 Pa	2 : 1	40 Pa

TRYKFORHOLD I OG OMKRING BYGNING

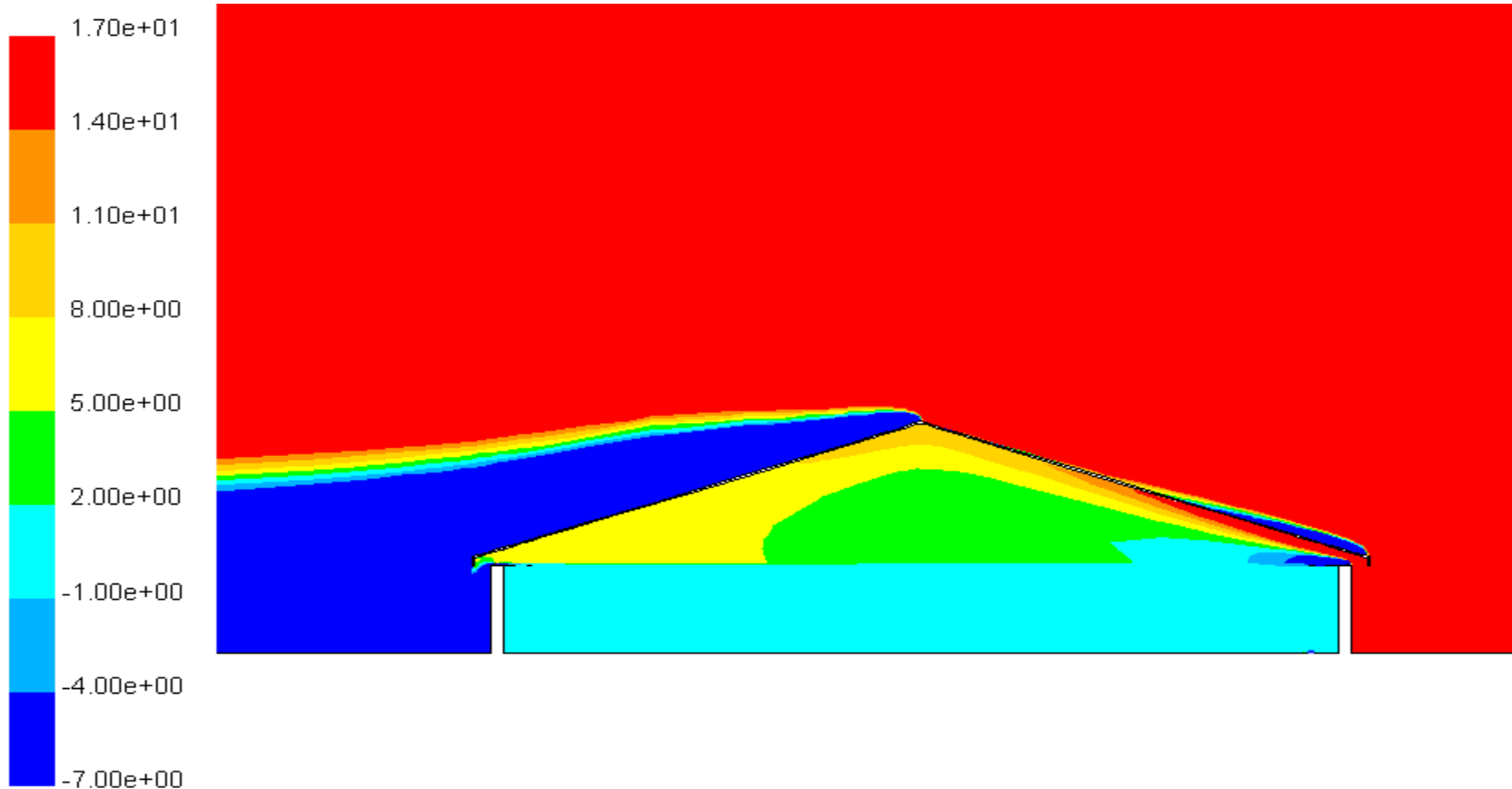

Contours of Total Pressure (pascal)

Aug 27, 2001
FLUENT 5.4 (2d, segregated, ke)

DISPOSITION

- Hvorfor ventilere
- God klimastyring
- Rengøring og udtørring
- Varmetilsætning
- Temperaturkurve

HVORFOR VENTILERE

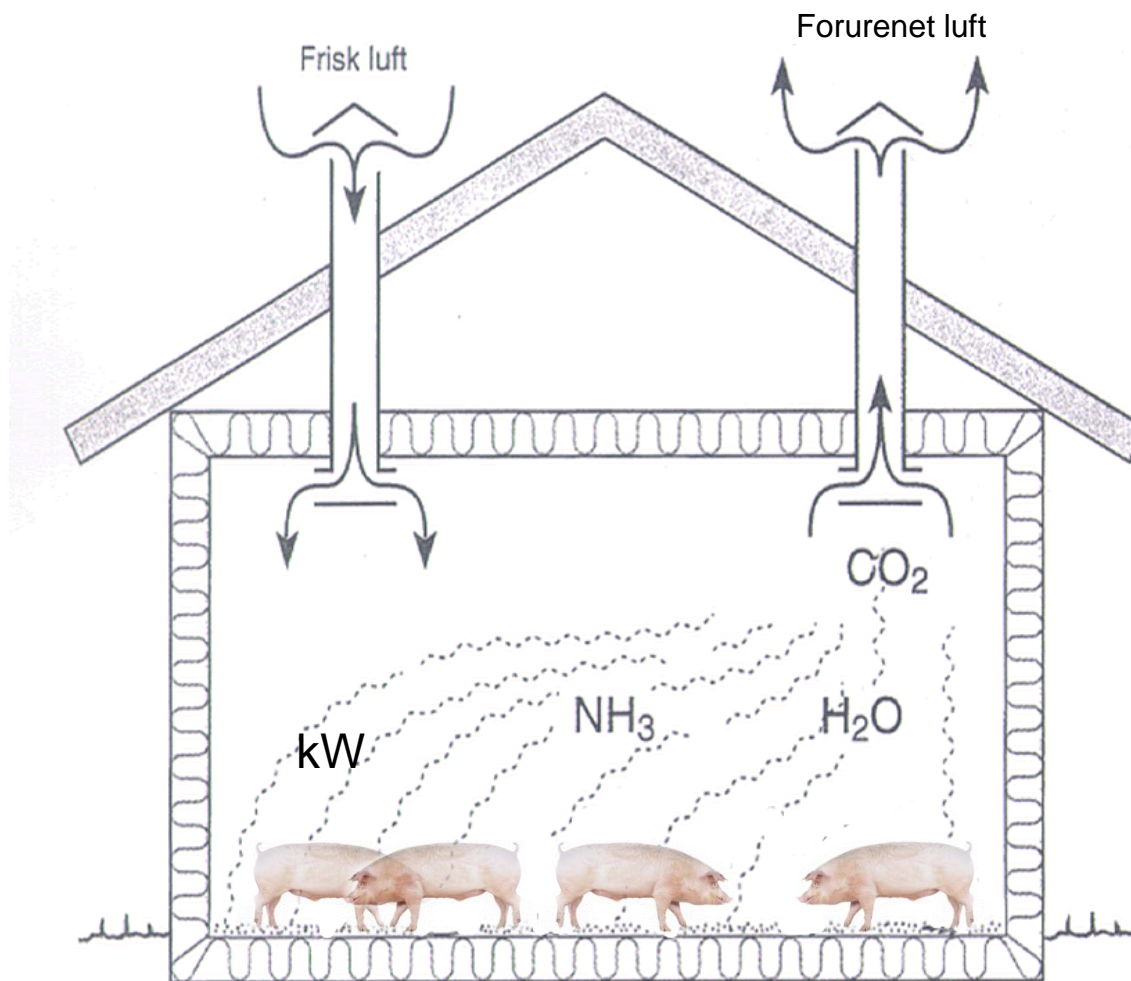

VEJLEDENDE DIMENSIONERINGSKRAV, M³/H PR. DYR

Staldtype	Minimum	Maksimum
Smågrise 20 kg.	3	30
Smågrise 25 kg.	4	35
Smågrise 30 kg.	6	45
Ungsvin 45 kg.	8	50
Slagtesvin, kont.	15	75
Slagtesvin, hold	15	100
Drægtige søer	15	100
Diegivende søer	30	300-400

HVOR STORT LUFTSKIFTE ?

Minimum ventilation pr. dyr

Vægt	Vanddamp	CO ₂
30 kg	6,5 m ³ /time	9,0 m ³ /time
100 kg	13 m ³ /time	18 m ³ /time

HVOR STORT LUFTSKIFTE ?

Maksimum ventilation pr. dyr
(udetemperatur 20° C)

Vægt	m ³ /time		
	Staldtemperatur		
	25° C	27° C	23° C
30 kg	36	25	59
100 kg	75	53	123

MAKSIMAL VENTILATIONSKAPACITET

Luftskifte m³/time pr. stiplads

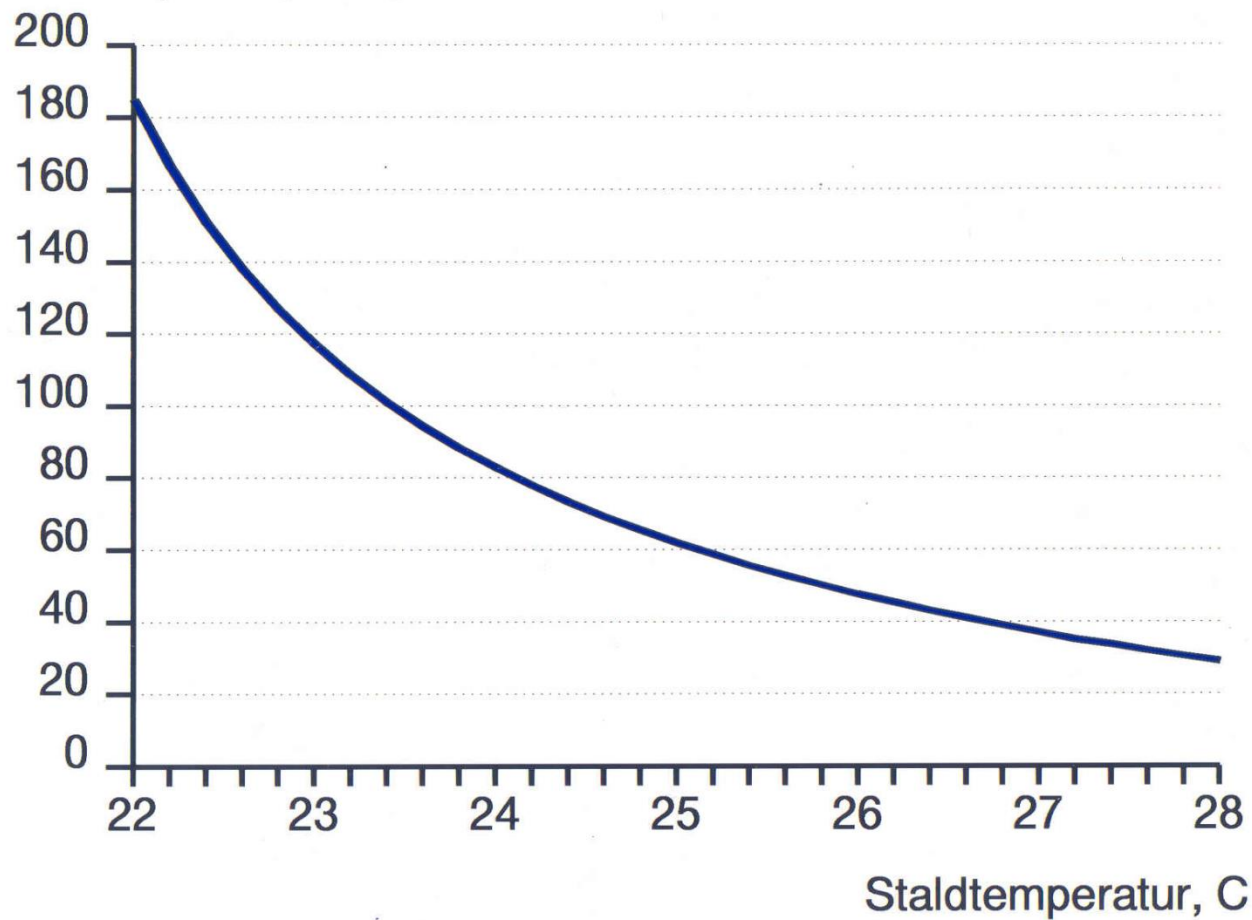

KONTROL AF ANLÆG

- Læs og lær manualer
- Lær styringen/anlægget at kende
- Strategi for brug af anlæg
- Faste rutiner for kontrol af anlæg

KONTROL AF ANLÆG

- Udsugning
- Ventililer



FALSK LUFTINDTAG



TRÆKFRI LUFTFORDDELING KRÆVER PLADS

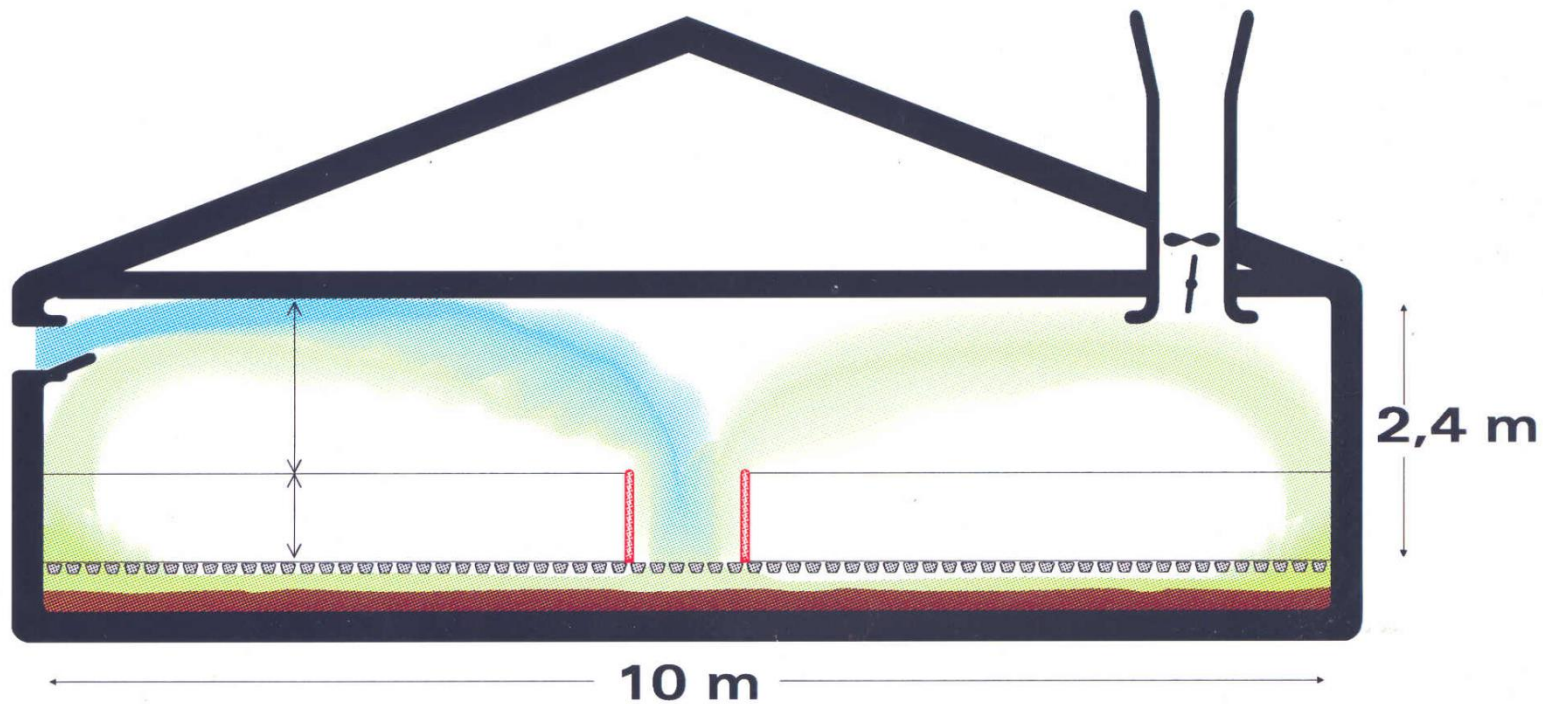

Mindst 0,3 meter pr. meter indtrængningslængde

UNDGÅ STIER PÅ TVÆRS AF LUFTINDTAG OG GANGVENTILATION



INDSTILLING AF LEDEPLADER



FASTHOLDELSE AF LEDEPLADE



HA' FOKUS PÅ – UDETEMPERATURKOMPENSERING



- Spjældbegrænsning ved faldende udetemperatur

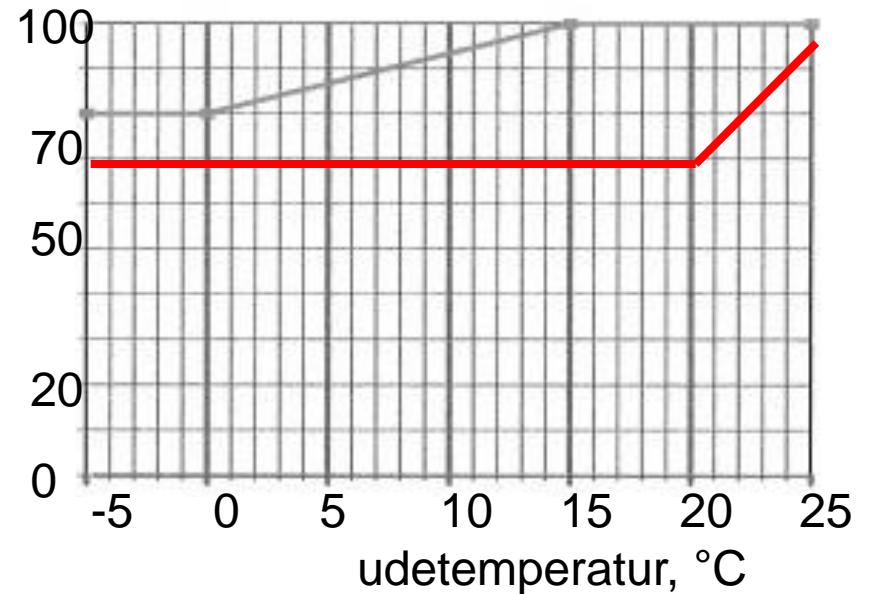

DIFFUST LUFTINDTAG



UNDERTRYKSVENTILATION DIFFUST LUFTINDTAG

- Dimensionering
- Randafdækninger
- Håndværk
- Stald-/stiindretning
- Luftindtag til loftet



DIFFUST LUFTINDTAG

- Beregning af isoleringstykkelse



DATA FOR LUFTGENNEMTRÆNGELIGHED

Materiale	Luftgennemtrængelighed (m ² /(h x Pa))
ISOVER (Glasuld 39)	0,64
ISOVER (Glasuld 42)	0,76
ISOVER diffusrulle	0,41
Rockwool A-diffusrulle	0,39

BEREGNING AF ISOLERINGSTYKKELSE

Isoleringstykkelsen (mm) kan beregnes ved følgende formel:

$$\text{mm} = \frac{35 \text{ Pa} \times 0,76 \text{ (m}^2\text{/(h} \times \text{Pa))}}{202 \text{ m}^3\text{/h/m}^2} = 132 \text{ mm}$$

DIFFUST LUFTINDTAG

- Fastgørelse af isolering



DIFFUST LUFTINDTAG

- Fastgørelse af isolering



DIFFUST LUFTINDTAG

- Fastgørelse af isolering



AFDÆKNINGER



AFDÆKNING UDFØRT KORREKT

- Tætte stalde –
sektionsvæg ført op

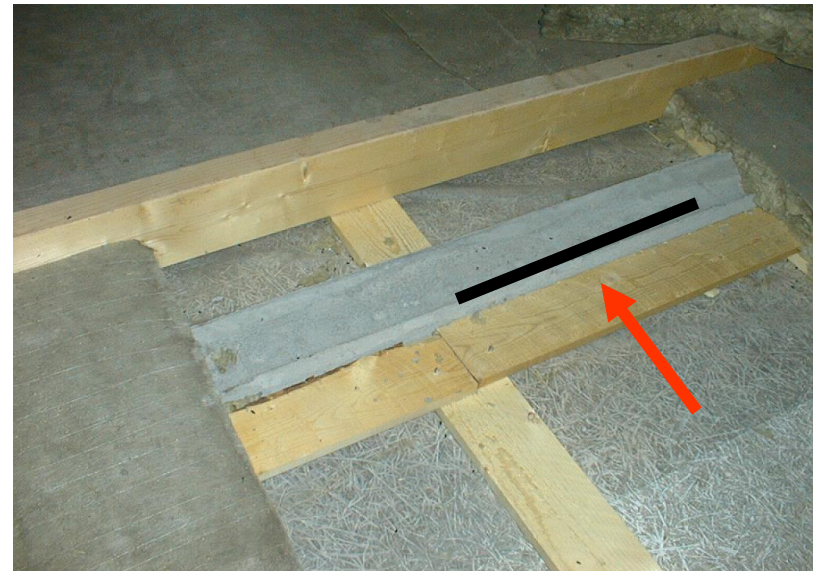

AFDÆKNING UDFØRT KORREKT

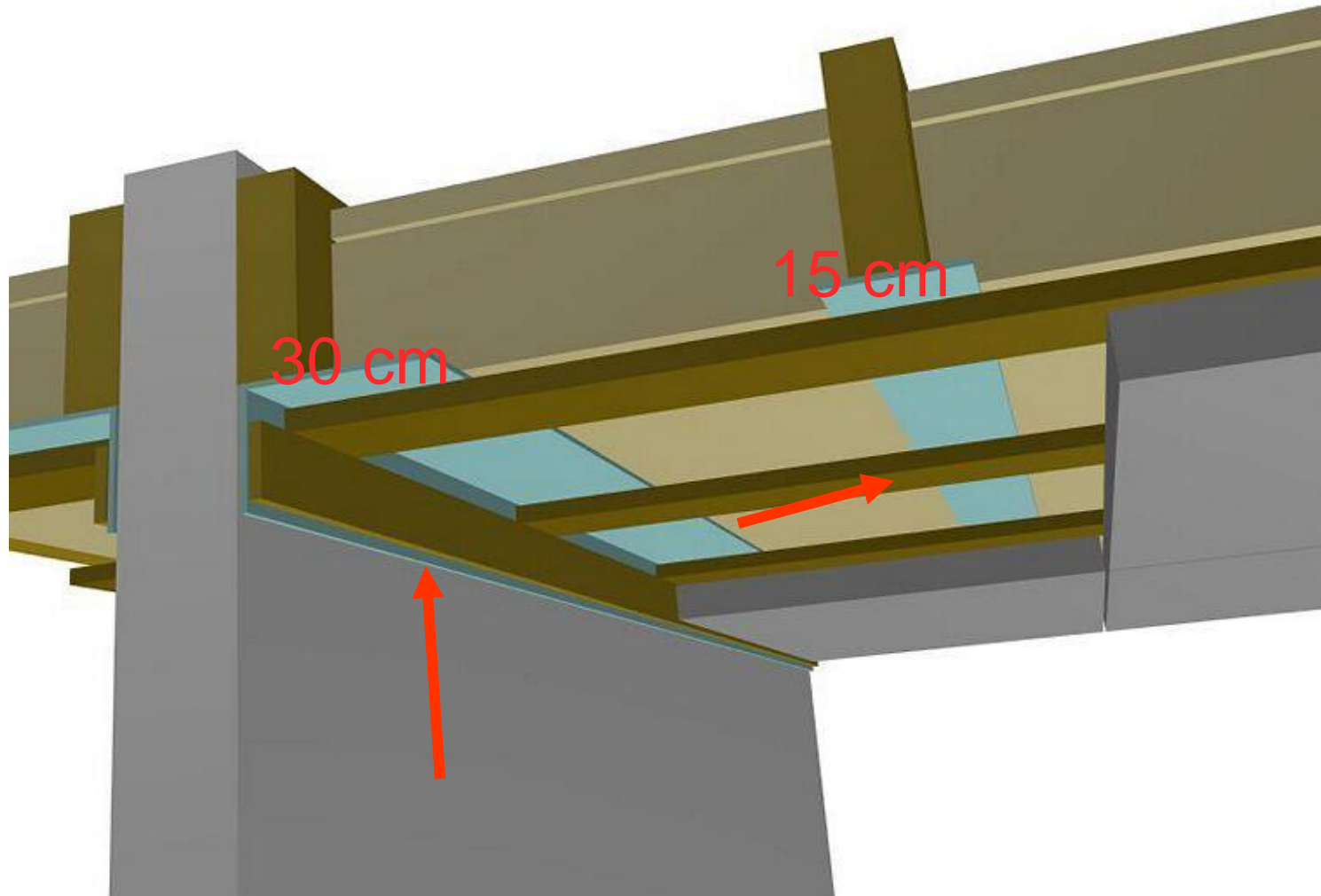

FEJL



FEJL



FEJL



FEJL



LUFTINDTAG TIL LOFTET

- Åbning under udhænget
2 – 3 cm² pr. m³ luft



UNDGÅ SOLOPVARMNING AF LOFTRUM



UTILSTRÆKKELIG SNEBRÆT



SNE OVER DET DIFFUSE LUFTINDTAG



DIFFERENTIERET ÅBNING TIL LOFTET

- Vinterindstilling

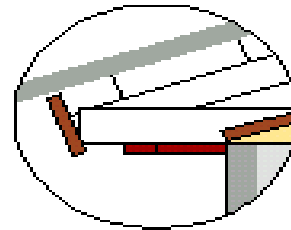

- Forårs-/efterårsindstilling

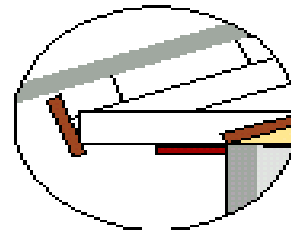

- Sommerindstilling

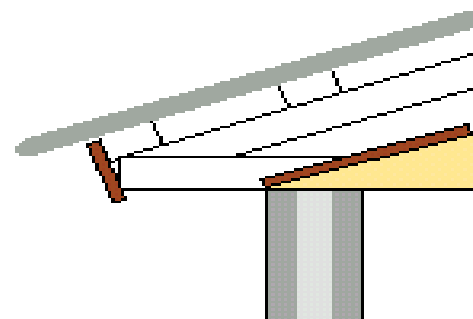

KONTROL AF UNDERTRYKSMÅLER

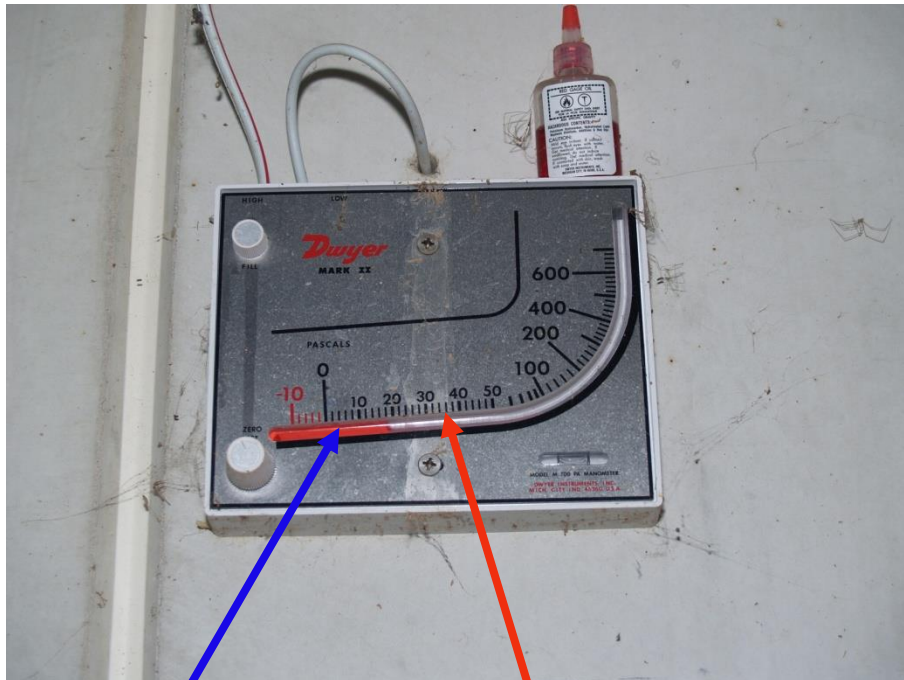

Minimum

Maksimum

- Begge slanger af
- Måler i vater
- Evt. påfyldning af olie
- Nulstilling af måler
- Begge slanger på
- Kontrol

KONTROL AF ANLÆG – KORREKT UNDERTRYK

Stald	Undertryk, Pa	
	Min. ventilation	Maks. ventilation
Diffus ventilation	2	30 - 40
Vægventiler, staldbredde < 12 m	7 - 10	5 - 7
Vægventiler, staldbredde 12-15 m *	10 - 15	8 - 10

Vejledende værdier for undertryk ved forskelligt ventilationsprincip og bygningsbredde. > **bygningensbredde + 1 Pa / m**

KONTROL AF ANLÆG

- Temperatur

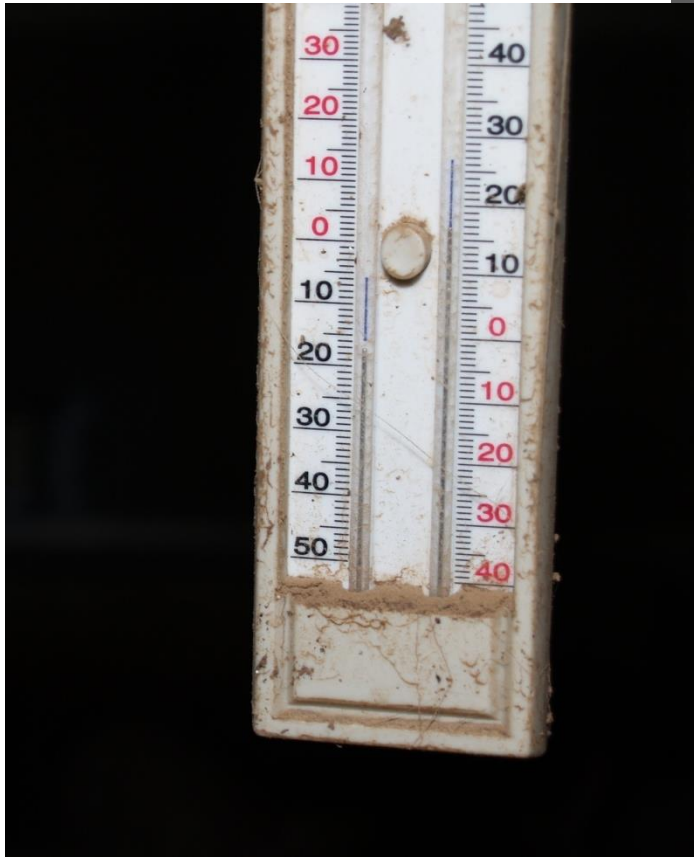

FOKUS PÅ TEMPERATURSTRATEGI

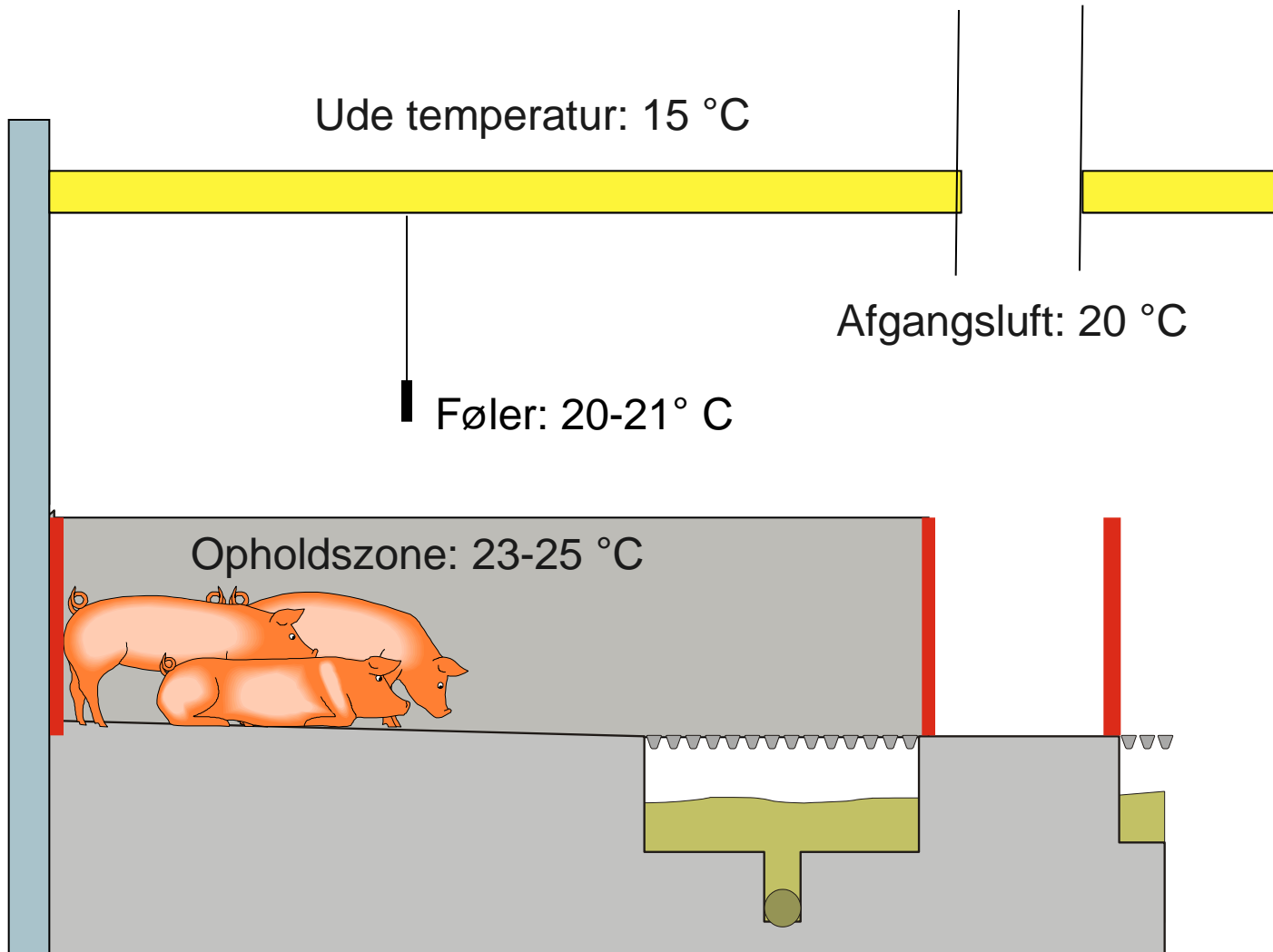

FOKUS PÅ TEMPERATURSTRATEGI (FØLERPLACERING)



KONTROL AF ANLÆG

- Temperatur



TEMPERATURSTRATEGI SE PÅ GRISENE



DER ER FOR KOLDT



HER ER TRÆK



DER ER VED AT VÆRE FOR VARMT



ØNSKET LIGGEADFÆRD I STI MED DELVIST SPALTEGULV



DET RIGTIGE KLIMA



FOKUS PÅ TEMPERATURSTRATEGI

Forslag til temperaturstrategi – **smågrise**, delvist fast gulv, ° C

Vægt, kg	7	10	14	18	21	25	30
Diffust luftindtag	22-24	22	21	20	19	18	17
Stråle-ventilation	23-25	23	23	22	21	20	20

FOKUS PÅ TEMPERATURSTRATEGI

Forslag til temperaturstrategi – **slagtesvin**, delvist fast gulv, ° C

Vægt, kg	25	30	40	50	60	70	80	90	100
Diffust luftindtag	18	17	16	16	15	14	14	13	13
Stråle-ventilation	20	20	19	18	17	16	15	15	15

FOKUS PÅ TEMPERATURSTRATEGI

Forslag til temperaturstrategi – **slagtesvin**,
fulldrænet gulv, ° C

Vægt, kg	25	30	40	50	60	70	80	90	100
Diffust luftindtag	20	19	18	18	17	16	16	15	15
Stråle- ventilation	21	20	20	19	19	18	18	18	18

EFFEKT AF KØLING

- Lufthastighed 1 m/s sænker overfladetemperaturen til 31,0° C
- Lufthastighed 0,3 m/s samt overbrusning sænker overfladetemperaturen til 28,5° C

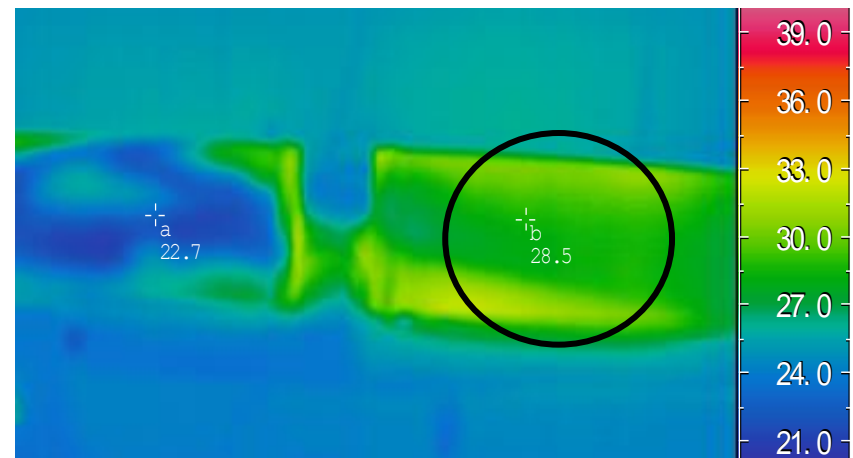
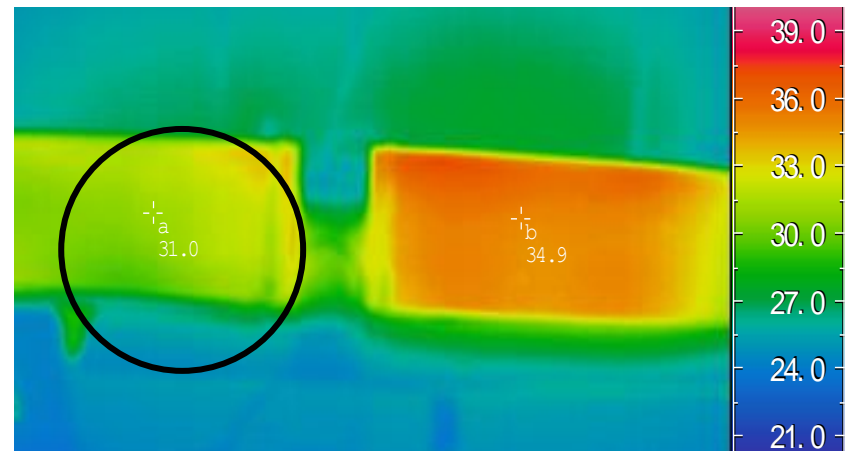

STRATEGI FOR OVERBRUSNING

- $< 14^{\circ}$ C anvendes overbrusning kun til Anvisning af gødeområde
- $> 14^{\circ}$ C overbrusning
Varighed 1 - 2 min. 1 - 2 gange / time
- $> 18^{\circ}$ C overbrusning
Varighed 2 - 3 min. 2 - 3 gange / time

GODT KLIMA FRA STARTEN

Konsekvensen af utilstrækkelig tørring er:

- Kolde gulve, vægge, inventar mm.
- Nedsat luftskifte, idet en stor del af varmeproduktionen går til vandfordampning
- Ringe effekt af rengøring over for smitte
- Gulvet sveder efter indsættelse af grise

EFFEKTIV RENGØRING/UDTØRRING



RENGØRING AF SKORSTENE



VÆRKTØJET

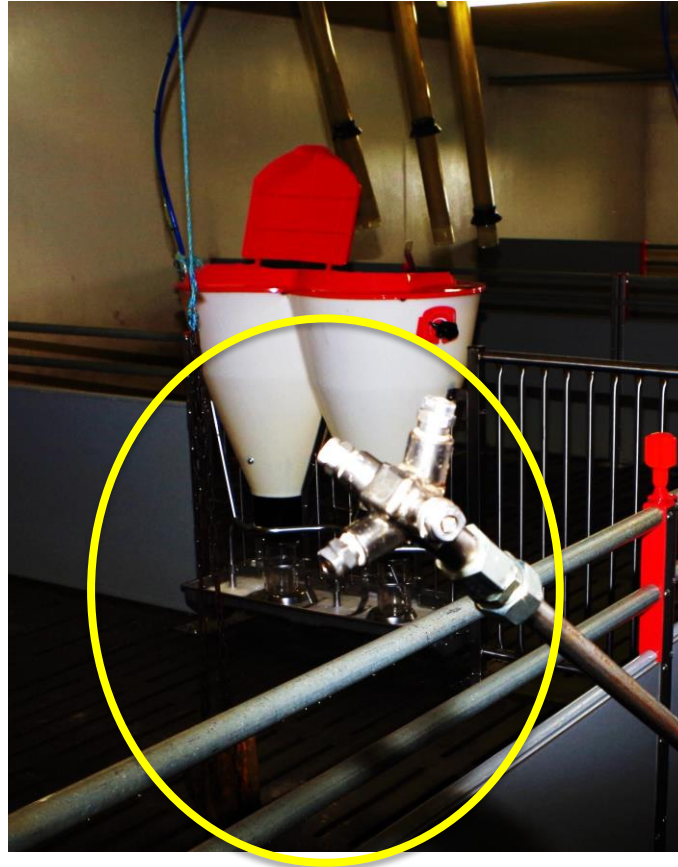

TØRRING AF STALD

Anbefaling - energiforbrug:

1,5 – 3 kWh/m² gulvflade

Problem:

1. Vandmængden der skal fordampes kendes ikke præcis. (Bedste bud 0,8 – 1,6 kg vand pr. m²)
2. Fordampningshastigheden aftager i løbet af tørringsperioden.

FORLØB AF TØRRING

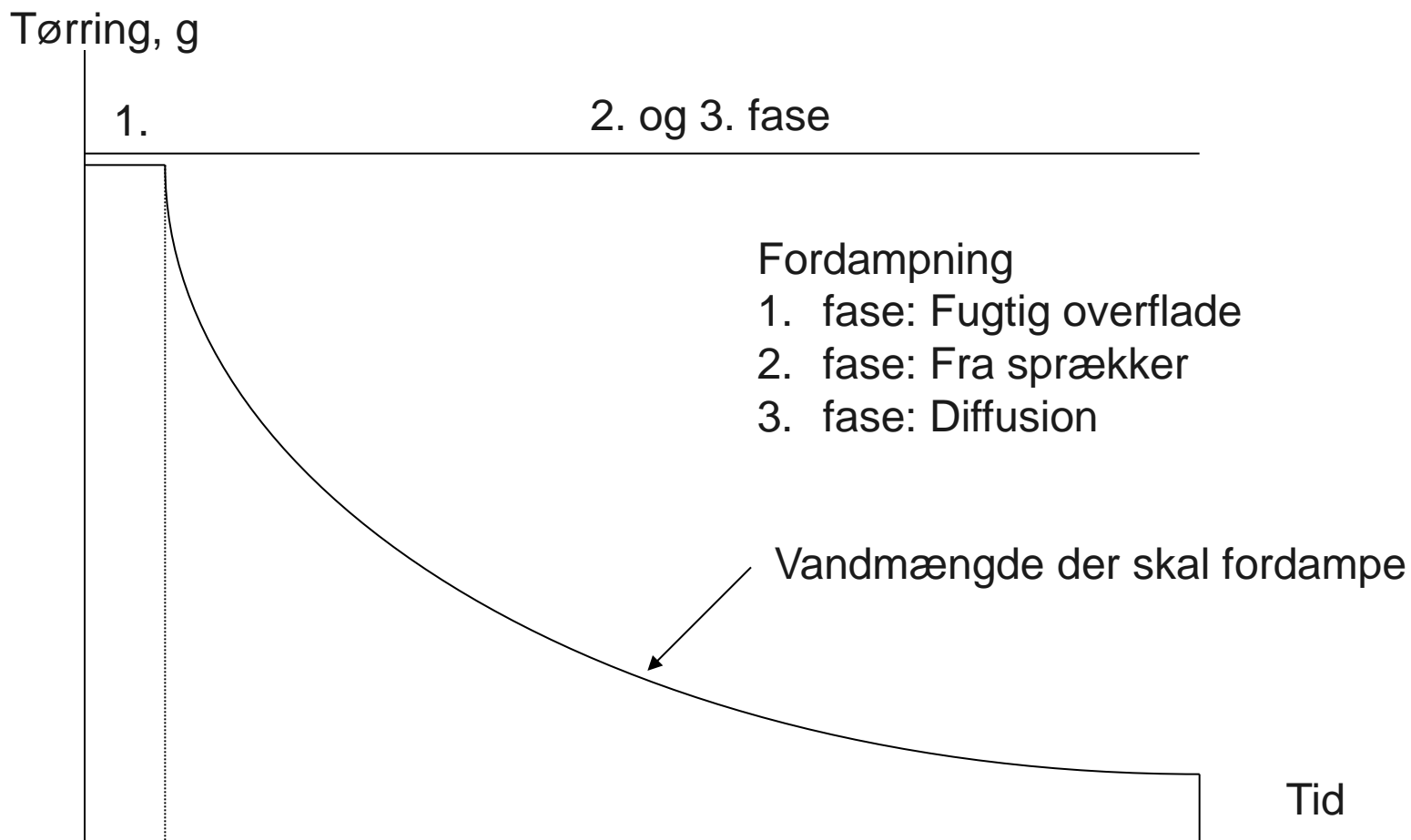

UDTØRRING VIA VARMEKANON ?



UDTØRRING VIA AFFUGTERE ?



Master Affugter DH 62 Prof

- Fremstillet af Master
- Kapacitet på 52 liter i døgnet

PÅSTAND : 200 M² STALD = 320 LITER VAND

Varmekanon, effekt 40 kW

- Forbrug :
 $3 \text{ kWt/m}^2 \times 200 \text{ m}^2$
 $= 600 \text{ kWt}$
- Tid:
 $600 \text{ kWt}/40 \text{ kW}$
 $= 15 \text{ timer}$
- Olieforbrug:
 $600 \text{ kWh}/10 \text{ kW/liter}$
 $= 60 \text{ liter}$

- Affugtere, effekt 52 l/døgn
 $= 2,2 \text{ l/time}$
- Tid:
 $320 \text{ l}/2,2 \text{ l/t} = 145 \text{ timer}$
6 døgn
- Energiforbrug:
 $145 \text{ timer} \times 1,2 \text{ kW}$
 $= 174 \text{ kWh}$

RENE SKORSTENE



RENE SKORSTENE

Beskidte = op til 20 % ekstra energi



Højtryksrensere

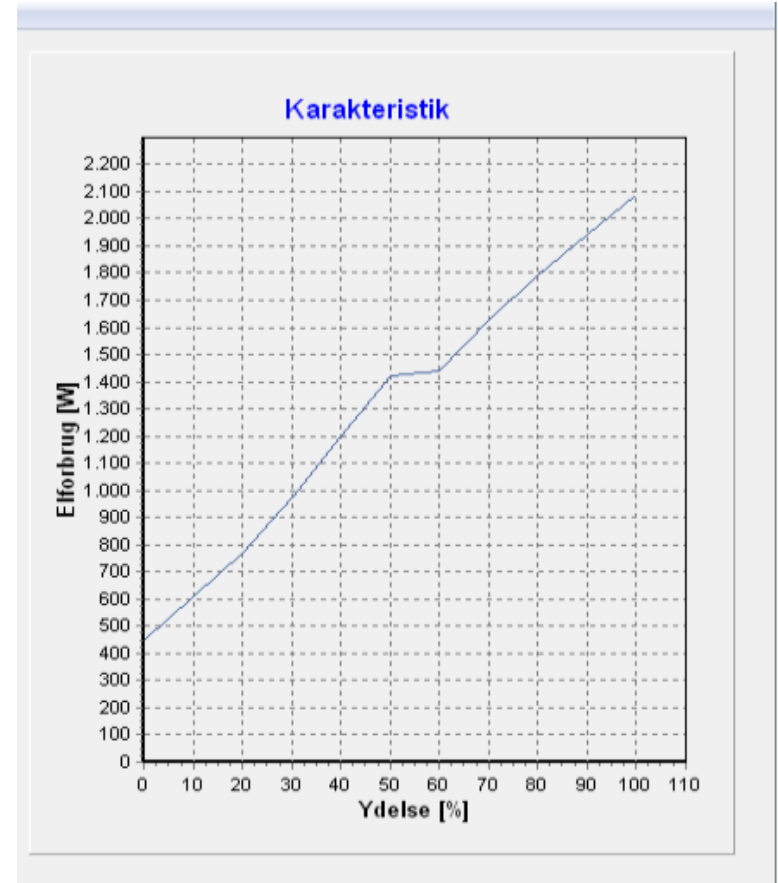

DIMENSIONERING - VARME

Effekt - slagtesvinestald



	Watt/stiplads (0,7 m ² /gris)	Beregnet
Rumvarme	10 – 40 *)	Staldvent

*) Udetemperatur, isolering, fordampningsfaktor m.v.

VARMEBEHOV, KW

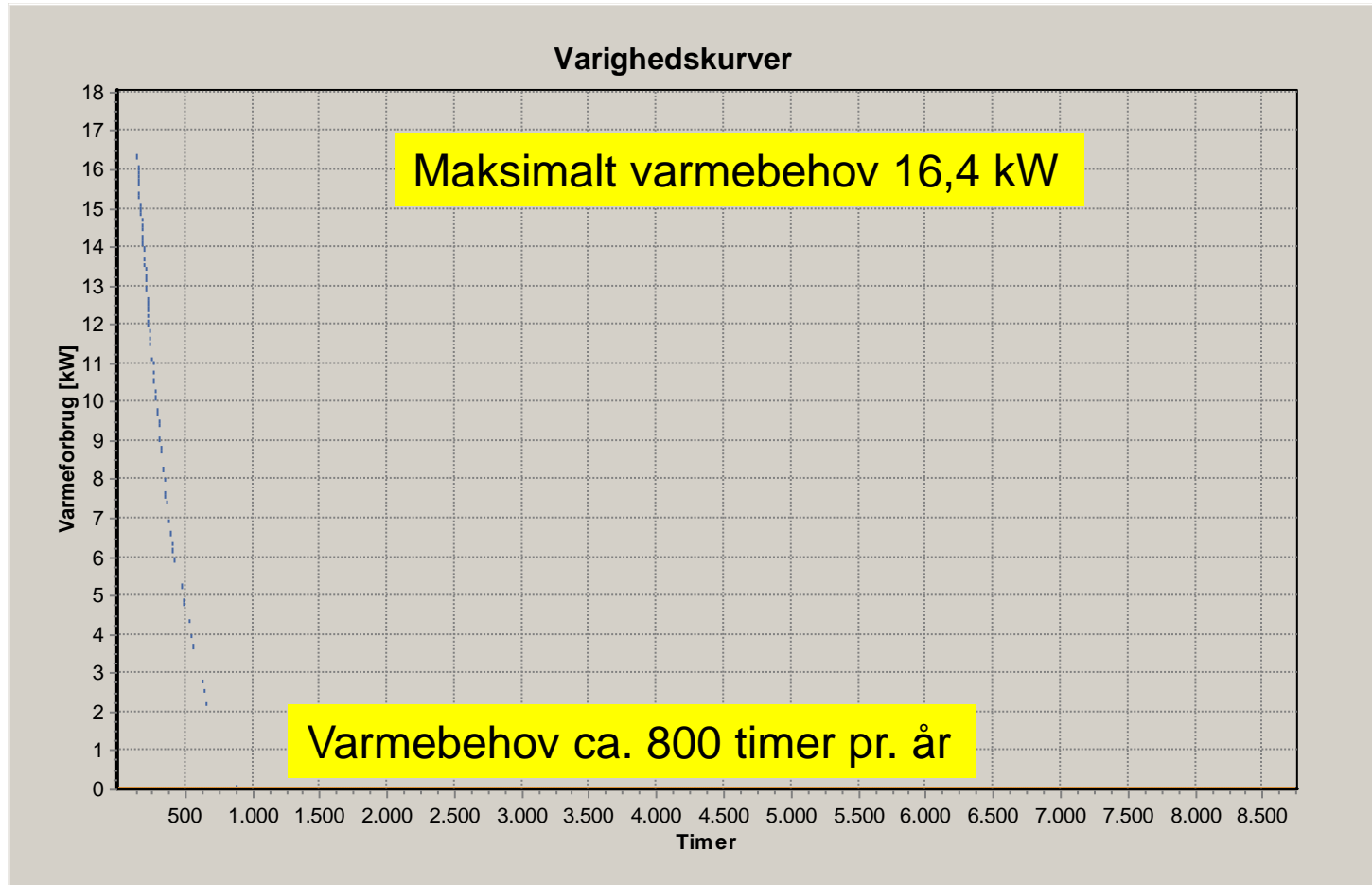

400 stipl. 30–105 kg, Temperatur 21–17° C, maks. 3.000 ppm CO₂

CO₂-KONCENTRATION

Varmetilførsel 16,4 kW

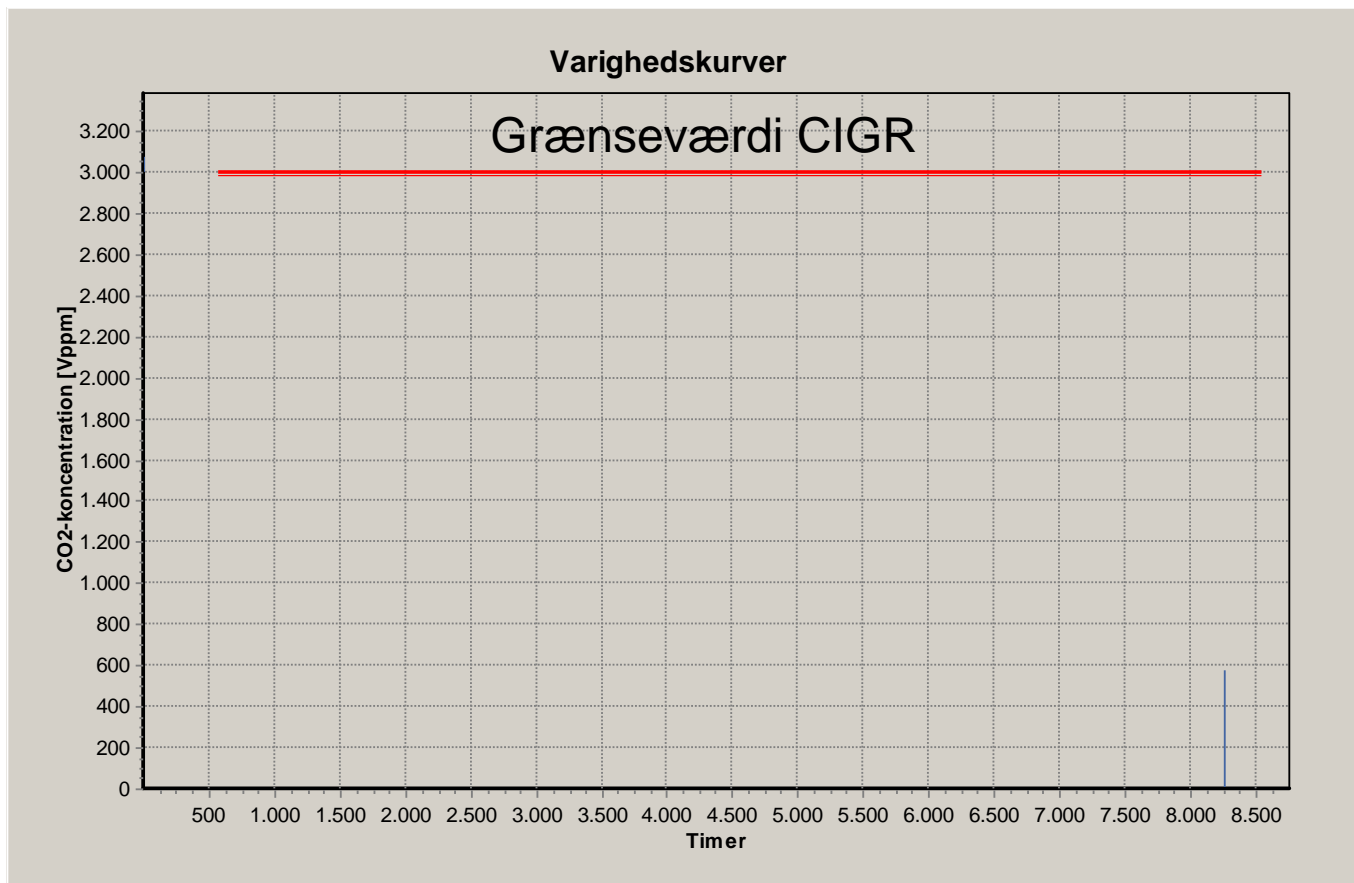

CO₂-KONCENTRATION

Uden varmetilsætning

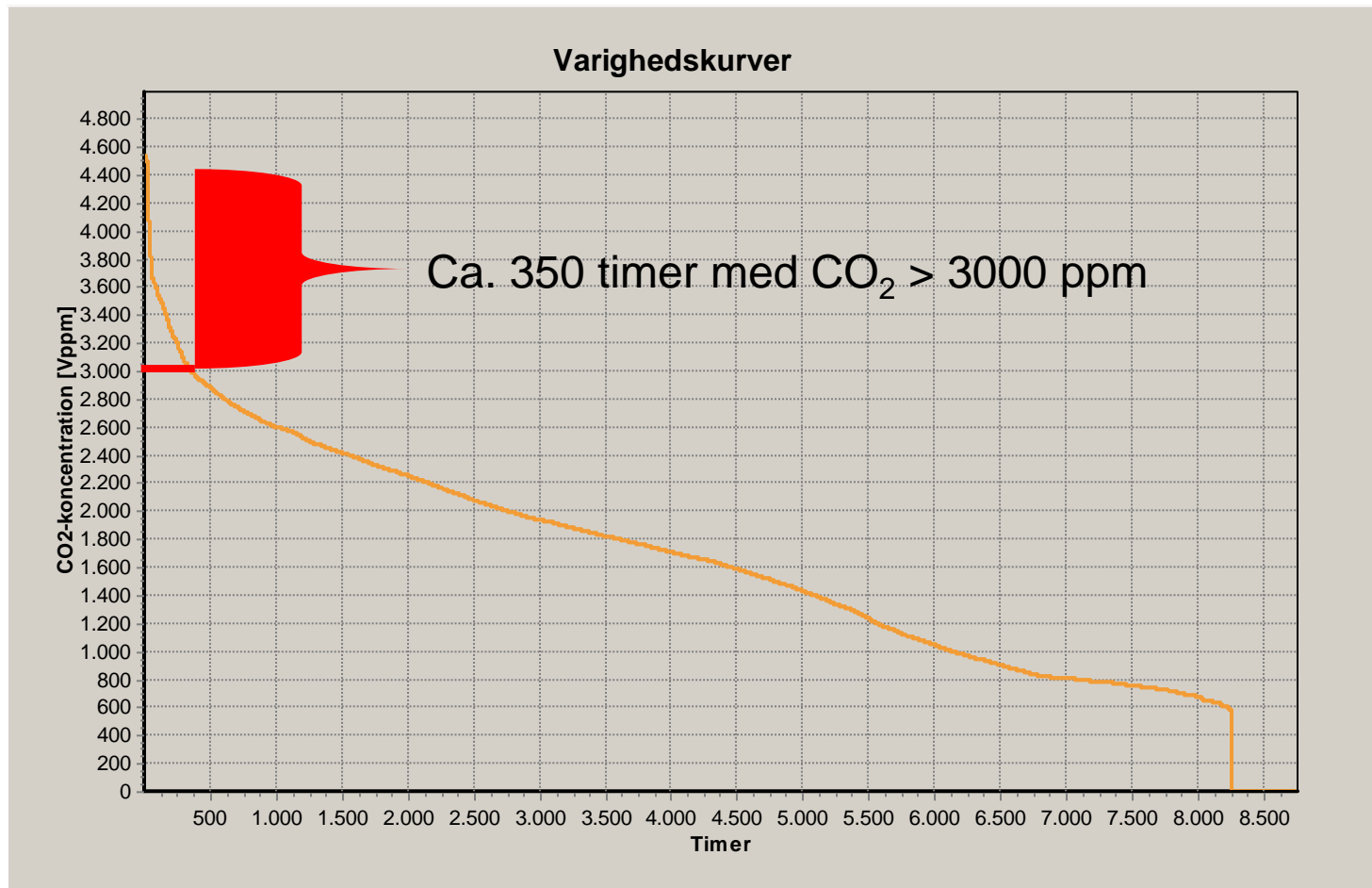

DIMENSIONERING

aldvent5.0 Varmesystem

Varmeydelse Hjælp

Dimensionering Varmesystem

Vandbåret varmesystem

Installeret varmeeffekt	W	16398,0
Staldtemperatur	°C	21,0
Fremløbstemperatur	°C	80,0
Returløbstemperatur	°C	50,0
Vandmængde	kg/h	469,8
Vandhastighed	m/s	0,21
Specifik varmeydelse	W/m	312,3
Minimum rørlængde	m	52,5



Årligt forbrug: 6.438 kWh
= 4 kWh/prod. gris

Overfør varmeeffekt

Varmesystem

- Elvarme
- Glatrør 4" galvaniseret
- Spiraflex 1"
- Spiraflex 1½"
- Fancom/Ikadan type Delta
- Agro Products type Wing Pipe
- Andet
- Intet varmesystem

Rørtype



ALARMANLÆG ER LOVKRAV



ALARMANLÆG



GODE STALDFORHOLD = GOD PRODUKTION



KONKLUSION

- Korrekt dimensionering
- Regelmæssig kontrol af anlæg
- Fokus på temperaturstrategi
- Effektiv udtørring
- Se på grisene – ”De giver tegnene”

SPØRGSMÅL

